

E 27 CLASS II 

Art.:800

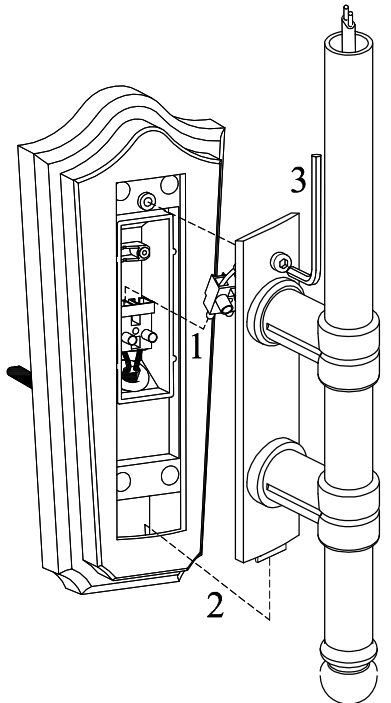

INSTR. N° 800
IX-2011

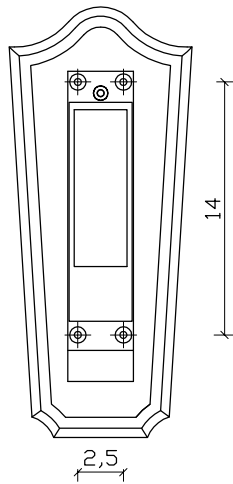
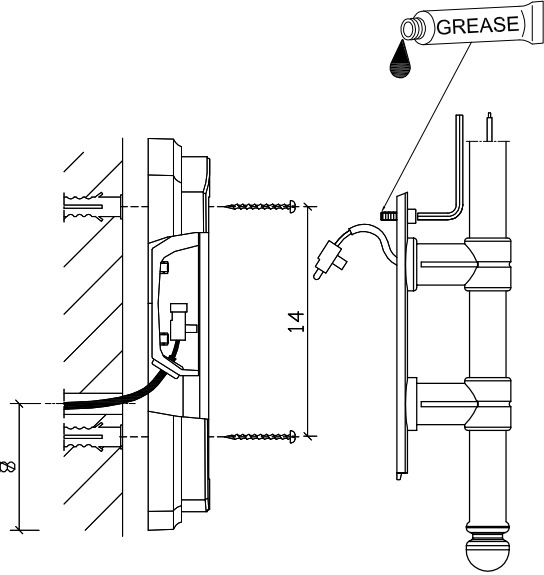
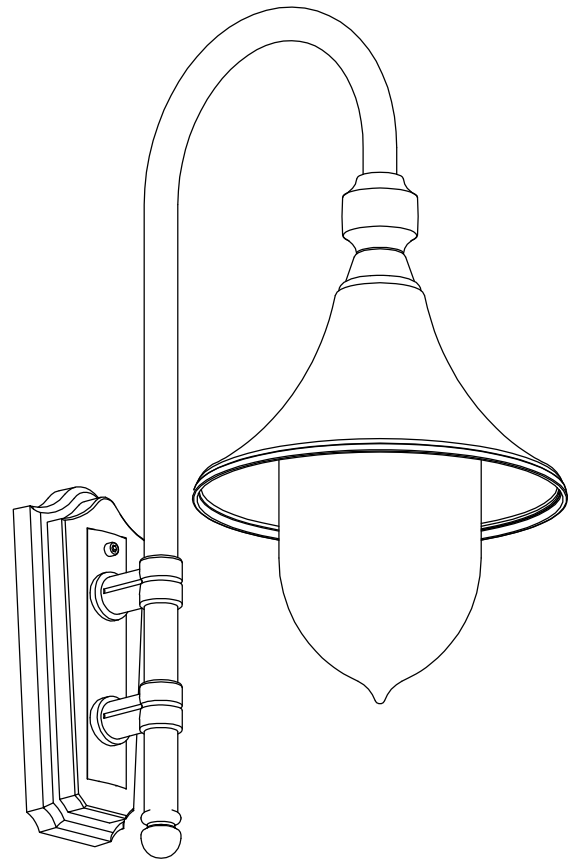
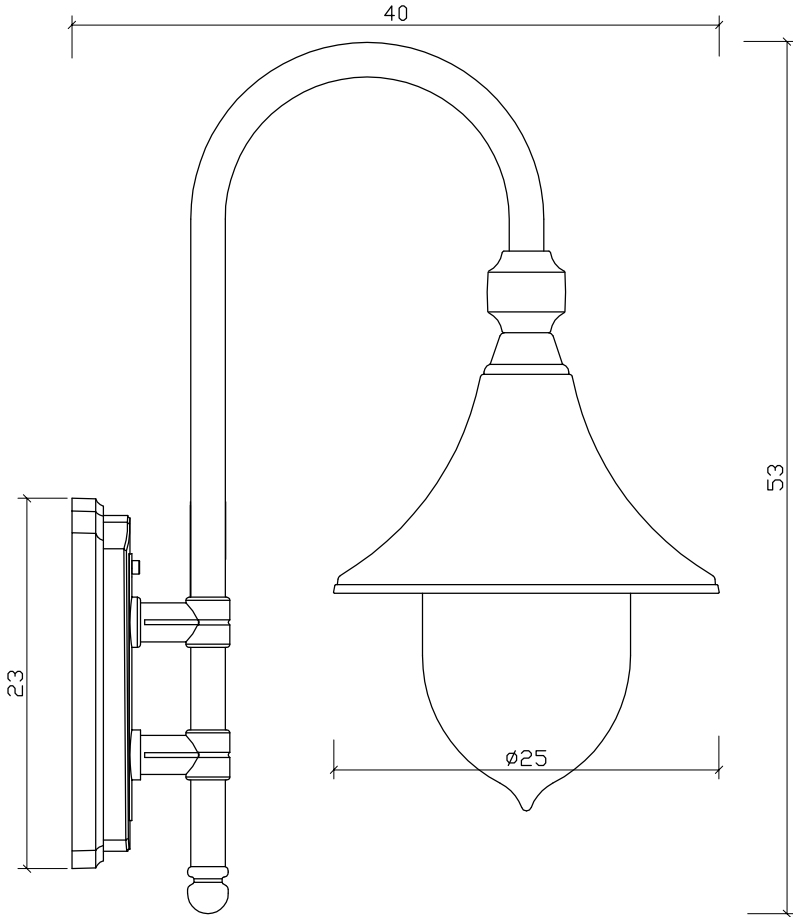
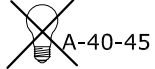
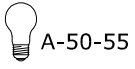